

PRODUCT SPECIFICATIONS

Elkay Lustertone™ Classic Stainless Steel 30-3/4" x 18-1/2" x 10"
Equal Double Bowl Undermount Sink with Right Perfect Drain. Sink is
manufactured from 18 gauge 304 Stainless Steel with a Lustrous Satin
finish, Rear Center drain placement, and Sides and Bottom pads.

Installation Type:	Undermount
Material:	304 Stainless Steel
Special Features:	Perfect Drain
Finish:	Lustrous Satin
Gauge:	18
Sound Deadening:	Sides and Bottom pads
Number of Bowls:	2
Sink Dimensions:	30-3/4" x 18-1/2" x 10"
Bowl 1 Dimensions:	13-1/2" x 16" x 10"
Bowl 2 Dimensions:	13-1/2" x 16" x 7-7/8"
Drain Size:	3-3/8" (86mm)
Drain Location:	Rear Center
Minimum Cabinet Size:	36"
Mounting Hardware:	Undermount brackets sold separately
Template Included:	Yes
Cutout Template #:	1000001312

Template is available for download at elkay.com. CAD software will be required to open the template.

Perfect Drain: Seamlessly welded stainless steel collar eliminates the gap between a traditional drain and the sink for a sanitary and gap free installation. Select garbage disposers can be installed on either sink bowl for user convenience. Please see our Garbage Disposer Compatibility Guide.

Hole Drilling Configurations:



Included with Product: Two LKPD1 Perfect Drains and strainers.

A Century of Tradition and Quality.
For more than 100 years, Elkay has been making innovative products and providing exceptional customer care. We take pride in offering plumbing products that make life easier, inspire change and leave the world a better place.

Product Compliance: ASME A112.19.3/CSA B45.4
Buy American Act
Accessory: ASME A112.18.2/CSA B125.2



Sinks are listed by IAPMO® as meeting the applicable requirements of the Uniform Plumbing Code®, International Plumbing Code®, and National Plumbing Code of Canada.

- [Clean and Care Manual \(PDF\)](#)
- [Installation Instructions \(PDF\) - 1000002045](#)
- [Installation Instructions \(PDF\) - 74180289_Dispenser](#)
- [Installation Instructions \(PDF\) - 74180340-USA_Drain](#)
- [Installation Instructions \(PDF\) - Garbage Disposer Compatibility Guide](#)
- [Limited Lifetime Warranty \(PDF\)](#)

Similar models are available with: small bowl on the opposite side

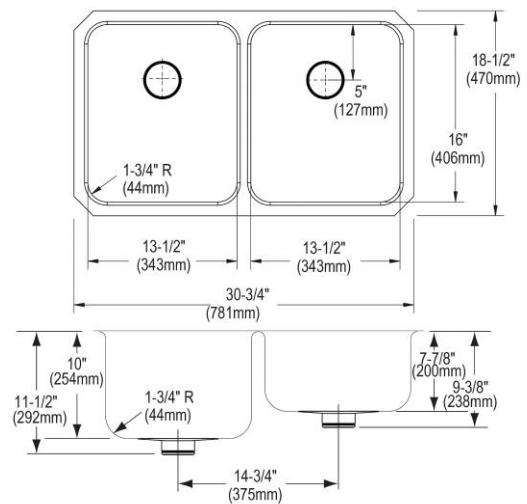

PART: _____ QTY: _____
 PROJECT: _____
 CONTACT: _____
 DATE: _____
 NOTES: _____
 APPROVAL: _____

In keeping with our policy of continuing product improvement, Elkay reserves the right to change product specifications without notice. Please visit elkay.com for the most current version of Elkay product specification sheets. This specification describes an Elkay product with design, quality, and functional benefits to the user. When making a comparison of other producers' offerings, be certain these features are not overlooked.

Installation Profile:

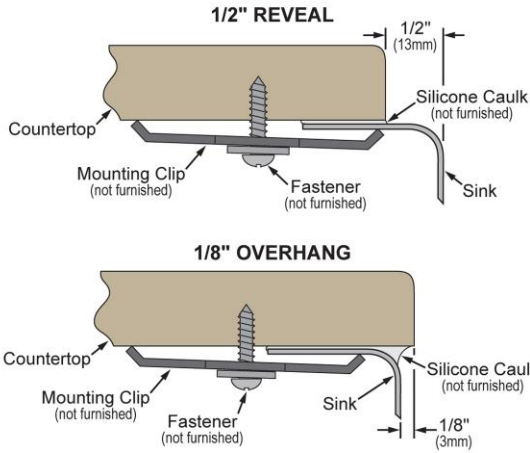



Optional Perfect Grid Drain
available (sold separately)
Model: LKPDVR18B

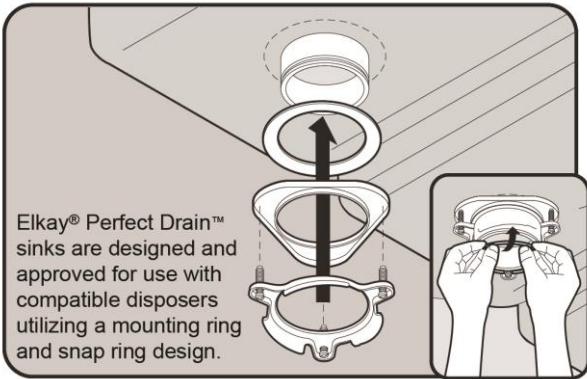



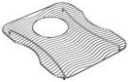

Designed to affix to the underside of any solid surface countertop.



Elkay® Perfect Drain™ sinks are designed and approved for use with compatible disposers utilizing a mounting ring and snap ring design.

Included Accessories		
LKPD1	Elkay Perfect Drain Fitting Type 304 Stainless Steel Body and Strainer Spec Sheet (PDF)	
Optional Accessories		
LKWOBG1316SS	Elkay Stainless Steel 12-1/2" x 15" x 1" Bottom Grid Spec Sheet (PDF)	
CB1613	Elkay Hardwood 16-3/4" x 13-1/2" x 1" Cutting Board Spec Sheet (PDF)	
CB1713	Elkay Hardwood 13-1/2" x 17" x 1" Cutting Board Spec Sheet (PDF)	

In keeping with our policy of continuing product improvement, Elkay reserves the right to change product specifications without notice. Please visit elkay.com for the most current version of Elkay product specification sheets. This specification describes an Elkay product with design, quality, and functional benefits to the user. When making a comparison of other producers' offerings, be certain these features are not overlooked.

CBS1316	<p>Elkay Hardwood 14-1/2" x 17" x 3/4" Cutting Board Spec Sheet (PDF)</p>	
LKDS35	<p>Elkay 3-1/2" Garbage Disposal Stopper / Strainer for use with Perfect Drain-Satin Finish Spec Sheet (PDF)</p>	
LKDS99	<p>Elkay 3-1/2" Garbage Disposal Stopper / Strainer for use with Perfect Drain-Chrome Polished Stainless Steel Spec Sheet (PDF)</p>	
LKPDVR18B	<p>Elkay Perfect Drain Chrome Plated Brass Body Vandal-resistant Strainer Spec Sheet (PDF)</p>	
LKGT1041	<p>Elkay Gourmet Single Hole Kitchen Faucet Pull-out Spray and Lever Handle with Hi and Mid-rise Base Options Spec Sheet (PDF)</p>	
LKWERBSS	<p>Elkay Stainless Steel 15-3/8" x 12-3/8" x 5-7/16" Rinsing Basket Spec Sheet (PDF)</p>	
LKWRB1316SS	<p>Elkay Stainless Steel 12-1/2" x 15" x 7" Rinsing Basket Spec Sheet (PDF)</p>	
LKSMHSL	<p>Spec Sheet (PDF)</p>	<p>NO IMAGE AVAILABLE</p>

In keeping with our policy of continuing product improvement, Elkay reserves the right to change product specifications without notice. Please visit elkay.com for the most current version of Elkay product specification sheets. This specification describes an Elkay product with design, quality, and functional benefits to the user. When making a comparison of other producers' offerings, be certain these features are not overlooked.